

DEI1046

OCTAL ARINC 429 LINE RECEIVER

NOT FOR NEW DESIGNS
REPLACED BY DEI1046A

FEATURES

- Octal ARINC 429 to TTL/CMOS logic line receivers
- Drop-in replacement for HI-8456PS_
- Operates from single +5 V \pm 10% or 3.3 V + 10% -5% power supply
- ARINC inputs internally protected to lightning requirements of DO-160 Level 3 pin injection
- Withstands inadvertent short to 115 Vac on inputs
- Operates in high noise environment
 - Input Common Voltage Range: \pm 20 V
 - 2 V minimum Input hysteresis
- High input resistance allows use of external series resistors to support:
 - Lightning protection beyond Level 3
 - Fault isolation
- Package: 38L TSSOP, 4.4 mm body

DEI1046 PINOUT

Table 1 DEI1046 Pin Description

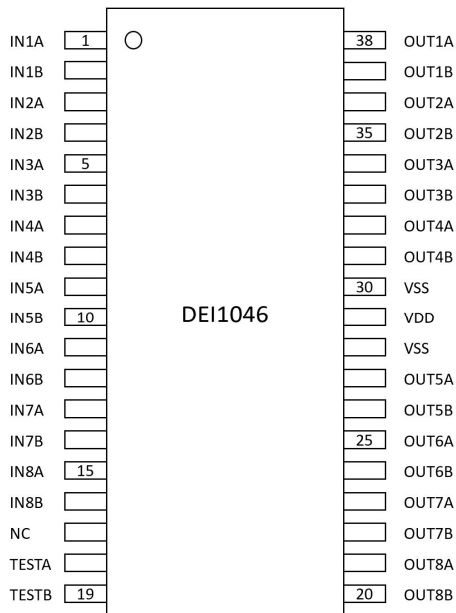

PIN	NAME	DESCRIPTION
15, 13, 11, 9, 7, 5, 3, 1	IN[8:1]A	429 INPUTS. ARINC 429 format serial digital data "A" inputs.
16, 14, 12, 10, 8, 6, 4, 2	IN[8:1]B	429 INPUTS. ARINC 429 format serial digital data "B" inputs.
17	NC	Not connected.
18	TESTA	LOGIC INPUT, Test input A
19	TESTB	LOGIC INPUT, Test input B
21, 23, 25, 27, 32, 34, 36, 38	OUT[8:1]A	LOGIC OUTPUTS. CMOS/TTL format serial digital data "A" outputs.
20, 22, 24, 26, 31, 33, 35, 37	OUT[8:1]B	LOGIC OUTPUTS. CMOS/TTL format serial digital data "B" outputs.
29	VDD	POWER INPUT. 5 V or 3.3 V.
28, 30	VSS	POWER INPUT. Ground.

FUNCTIONAL DESCRIPTION

The DEI1046 is a BiCMOS device which contains eight differential line receivers. Each receiver channel translates incoming ARINC 429 data bus signals (tri-level RZ bipolar differential modulation) to a pair of TTL/CMOS logic outputs. Each channel operates independently and meets the requirements of the ARINC 429 Digital Information Transfer Standard. Refer to Figure 1 DEI1046 Block Diagram and Truth Table.

The device is designed to operate in a high noise environment. Inputs are accepted over a ± 20 V common mode voltage range and the receivers provide over 2 V of hysteresis. Circuit speed is optimized to reject high frequency transients.

The DEI1046 device provides logic level TEST inputs for built in system test. They force the outputs of all eight receivers to the specified ZERO, ONE or NULL state. The ARINC inputs are ignored when the device is in test mode. The DEI1046 has a single test port which controls all 8 channels.

The ARINC input pins are designed with internal protection from damage due to lightning induced transients of DO-160 Level 3 pin injection. The protection incorporates on-chip high value resistors to minimize IR heating and high-voltage dielectric isolation to withstand the voltage transients.

Higher protection levels can be achieved with the addition of external TVS devices between the inputs and ground, or alternately, TVS devices in combination with series current limiting resistors between the ARINC bus and the IC/TVS node. The series resistors reduce the power requirement and size of the TVS. Resistor values up to 10 k Ω are feasible.

The ARINC inputs withstand inadvertent short to 115 Vac aircraft power without sustaining damage.

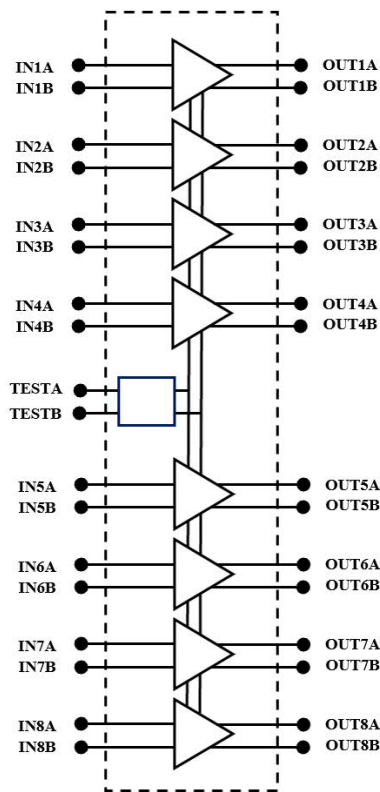

INPUTS			OUTPUTS		
TEST INPUTS (TTL/CMOS)		ARINC INPUTS	TTL/CMOS		
TESTA	TESTB	INA - INB	OUTA	OUTB	Logic
0	0	Logic +1	1	0	ONE
0	0	Logic -1	0	1	ZERO
0	0	NULL	0	0	NULL
0	1	X	0	1	ZERO
1	0	X	1	0	ONE
1	1	X	0	0	NULL

Figure 1 DEI1046 Block Diagram and Truth Table

ELECTRICAL DESCRIPTION

Table 2: Absolute Maximum Rating

PARAMETER	MIN	MAX	UNIT
Supply Voltage (with respect to VSS)	-0.3	7.0	V
Storage Temperature	-65	+150	°C
Input Voltage, continuous (ARINC Inputs)		115	Vac
Power Dissipation @ 85 °C		800	mW
Junction Temperature, Tjmax (limited by molding compound Tg)		145	°C
Peak Body Temperature		260	°C
Lightning Protection (ARINC 429 Channel Inputs)			
Waveform 3 (2)	-720	+720	V
Waveform 4, 5A (2) (3)	-360	+360	V
ESD JS-001-2017 HBM	1B		Class
Notes:			
1. Stresses above these limits can cause permanent damage.			
2. Per DO160, Sect 22 Level 3 pin injection. See Figures 4 - 6.			
3. Inputs can be protected to withstand higher stress by adding series resistors and shunt TVS on inputs. Inputs withstand 1500 V Waveform 5A when clipped \leq 600 V.			

Table 3: Recommended Operating Conditions

PARAMETER	SYMBOL	CONDITIONS
Supply Voltage	VDD	+5 V \pm 10% +3.3 V +10% -5%
Logic Input Levels	TESTA/B	0 to VDD
Operating Temperature	Ta	-55 to +85 °C -55 to +125 °C
-TES		
-TMS		

Table 4: Electrical Characteristics

Conditions: Temperature: -55 °C to +85 °C (-TES); -55 °C to +125 °C (-TMS) VDD = +5 V ±10% and +3.3 V +10% -5%					
PARAMETER	TEST CONDITION	SYMBOL	MIN	MAX	UNIT
ARINC INPUTS					
$V_A - V_B = \text{Logic } +1$	OUTA = 1	V_{+1}	6.5	13	V
$V_A - V_B = \text{Logic } -1$	OUTB = 1	V_{-1}	-6.5	-13	V
$V_A - V_B = \text{Logic Null}$	OUTA = 0 OUTB = 0	V_{NULL}	-2.5	2.5	V
Input Hysteresis		V_{HY}	2.0	4.0	V
Input Common Mode Voltage Range	Logic +1, Null, Logic -1	V_{CM}	-20	+20	V
Input Resistance IN_A to IN_B	VDD open, Shorted to VSS or +5 V (1)	R_{IN}	280		k Ω
Input Resistance IN_A or IN_B to V_{SS}	VDD open, Shorted to VSS or +5 V	R_{S}	140		k Ω
Input Capacitance IN_A to IN_B	VDD open, Shorted to VSS or +5 V (1)	C_{IN}		10	pF
Input Capacitance IN_A or IN_B to V_{SS}	VDD open, Shorted to VSS or +5 V (1)	C_{S}		10	pF
LOGIC INPUTS					
Logic 0 Voltage		V_{IL}		0.8	V
Logic 1 Voltage		V_{IH}	2.0		V
Logic 0 Current	$V_{\text{IL}} = 0.8$	I_{IL}		25	μA
Logic 1 Current	$V_{\text{IH}} = 2.0$	I_{IH}		50	μA
LOGIC OUTPUTS					
OUTPUT HIGH VOLTAGE TTL	$I_{\text{OH}} = -5\text{mA}$ (VDD = 5.0 V) $I_{\text{OH}} = -5\text{mA}$ (VDD = 3.3 V) TTL Compatible	V_{OH}	2.4		V
OUTPUT LOW VOLTAGE TTL	$I_{\text{OL}} = 5\text{ mA}$ (VDD = 5.0 V)	V_{OL}		0.4	V
OUTPUT HIGH VOLTAGE CMOS	$I_{\text{OH}} = 100\ \mu\text{A}$ CMOS Compatible	V_{OH}	VDD -.05		V
OUTPUT LOW VOLTAGE CMOS	$I_{\text{OL}} = 100\ \mu\text{A}$ CMOS Compatible	V_{OL}		.05	V
SUPPLY CURRENT					
VDD Current	Data Rate = 0 MHz, $IN_A/B = \text{open}$, $OUTA/B = \text{open}$, VDD = 5.5 V or 3.63 V	I_{DD}	1.5	8.5	mA
Notes:					
1. Guaranteed by design, not production tested.					
2. Current flowing into device is positive. Current flowing out of device is negative. All voltages are with respect to VSS unless otherwise noted.					

Table 5: Switching Characteristics

PARAMETER	TEST CONDITION (1,2)	SYMBOL	MAX VDD 3.3V	MAX VDD 5V	UNIT
INA/B to OUTA/B Prop Delay	TESTA = TESTB = 0 C _L = 50 pF	t _{LH}	1000	900	ns
INA/B to OUTA/B Prop Delay	TESTA = TESTB = 0 C _L = 50 pF	t _{HL}	1000	900	ns
OUTA/B rise time	10% to 90%, C _L = 50 pF	t _r	50	25	ns
OUTA/B fall time	10% to 90%, C _L = 50 pF	t _f	50	25	ns
TESTA/B to OUTA/B Prop delay	C _L = 50 pF	t _{TOH}	100	60	ns
TESTA/B to OUTA/B Prop delay	C _L = 50 pF	t _{TOL}	100	60	ns

Notes:

1. Sample tested.
2. Refer to Figures 2 – 3.

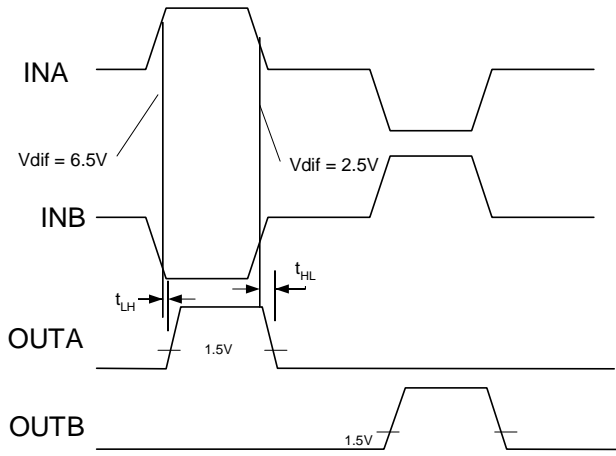

Figure 2 ARINC 429 Input to Logic Output Switching Waveform

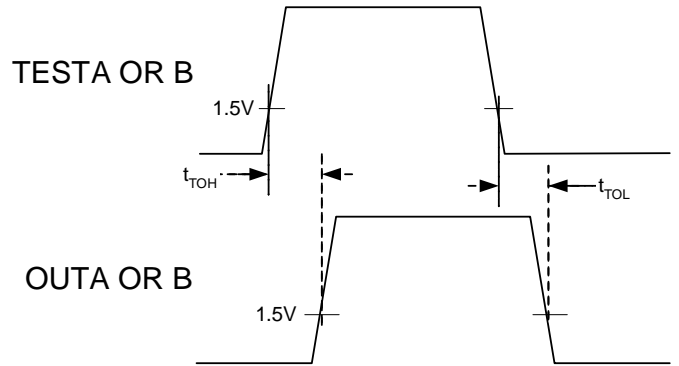

Figure 3 TEST Input to Logic Output Switching Waveform

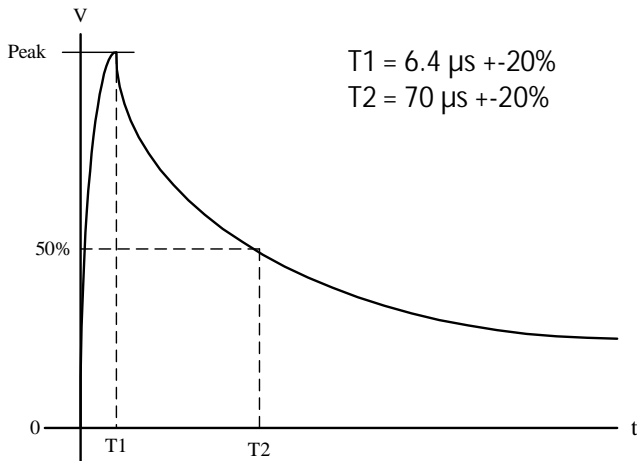

Figure 4 DO160 Lightning Induced Transient Voltage Waveform #4 Pin Injection
Voc = 300 V, Isc = 60 A

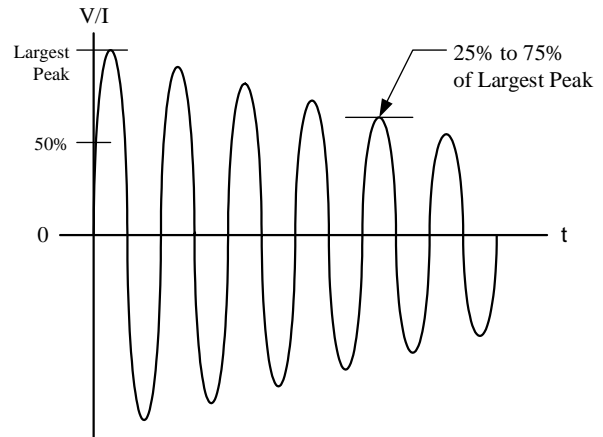

Figure 5 DO160 Lightning Induced Transient Voltage Waveform #3 Pin Injection
Voc = 600 V, Isc = 24 A. Freq = 1 MHz ±20%

LIGHTNING TRANSIENT NOTES:

1. Voc = Peak Open Circuit Voltage available at the calibration point.
2. Isc = Peak Short Circuit Current available at the calibration point.
3. Amplitude tolerances: +10%, -0%.
4. The ratio of Voc to Isc is the generator source impedance to be used for generating the waveforms.

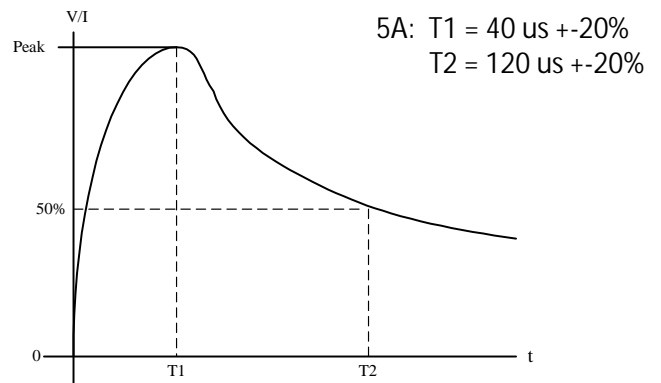

Figure 6 DO160 Lightning Induced Transient Voltage Waveform #5 Pin Injection
Voc = 300 V, Isc = 300 A

ORDERING INFORMATION

Table 6: Ordering Information

DEI PN	MARKING (1)	TEST INPUTS	TEMPERATURE RANGE	PACKAGE	SCREENING
DEI1046-TES-G	DEI1046-TES (e4)	YES	-55/+85 °C	38L TSSOP G	Standard
DEI1046-TMS-G	DEI1046-TMS (e4)	YES	-55/+125 °C	38L TSSOP G	Standard

Notes:
1. All packages marked with Lot Code and Date Code. (e4) after Date Code denotes Pb Free category.

Table 7: Screening Process

SCREENING	STANDARD
ELECTRICAL TEST:	
ROOM TEMPERATURE	100%
HIGH TEMPERATURE	100% @ 85 °C or 125 °C
LOW TEMPERATURE	0.65% AQL @ -55 °C

PACKAGE DESCRIPTION

Table 8: Package Characteristics

CHARACTERISTIC	VALUE
REFERENCE	38L TSSOP G
Θ_{JA} (4 layer PCB with Power Planes)	75 °C/W
Θ_{JC}	15 °C/W
JEDEC MOISTURE SENSITIVITY LEVEL (MSL)	MSL 2 / 260 °C
LEAD FINISH MATERIAL / JEDEC Pb-free CODE	NiPdAu e4
Pb-Free DESIGNATION	RoHS Compliant
JEDEC REFERENCE	MO-153-BD-1

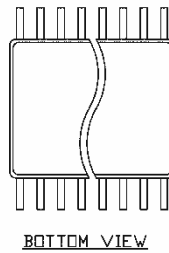
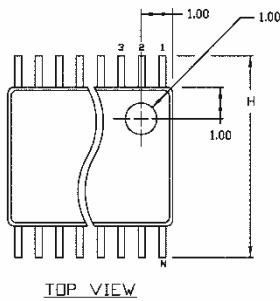

SYMBOL	COMMON DIMENSIONS			
	MILLIMETERS		INCHES	
	MIN.	MAX.	MIN.	MAX.
A	—	1.10	—	.043
A ₁	0.05	0.15	.002	.006
A ₂	0.85	0.95	.033	.037
b	0.17	0.27	.0067	.0106
b ₁	0.17	0.23	.0067	.0091
c	0.090	0.200	.0035	.0079
c ₁	0.090	0.135	.0035	.0053
D	9.60	9.80	.3780	.3858
E	4.30	4.50	.169	.177
e	0.50 BSC	—	.0197 BSC	—
H	6.30	6.50	.248	.256
L	0.50	0.70	.020	.028
α	0°	8°	0°	8°

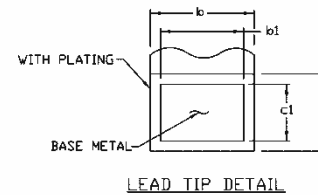
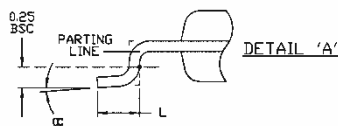
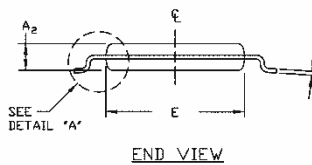
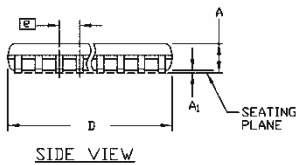

Figure 7 38L TSSOP Mechanical Outline

DEI reserves the right to make changes to any products or specifications herein. DEI makes no warranty, representation, or guarantee regarding suitability of its products for any particular purpose.